

ISO 2768-C GENERAL TOLERANCES
LINEAR AND ANGULAR DIMENSIONS

DIN 6930-C STAMPED STEEL PARTS
FLAT SURFACES / BENDINGS

ISO 13920-BG WELDINGS
WELDED CONSTRUCTIONS

Model
Drawing VFEP304020A.dwg

1 2 3 4 5 6 7 8

ID	Description	Date	By	Appr.
A	1.	23.7.18	PLe	

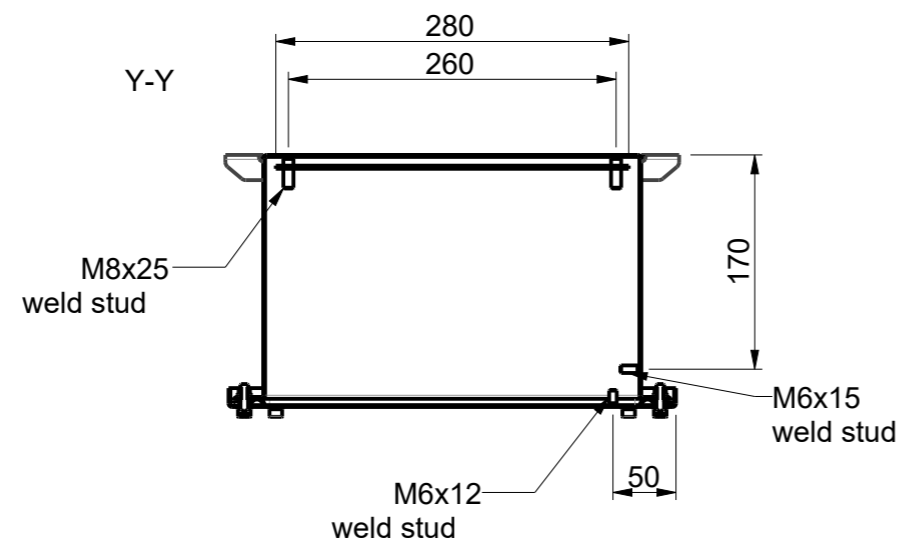
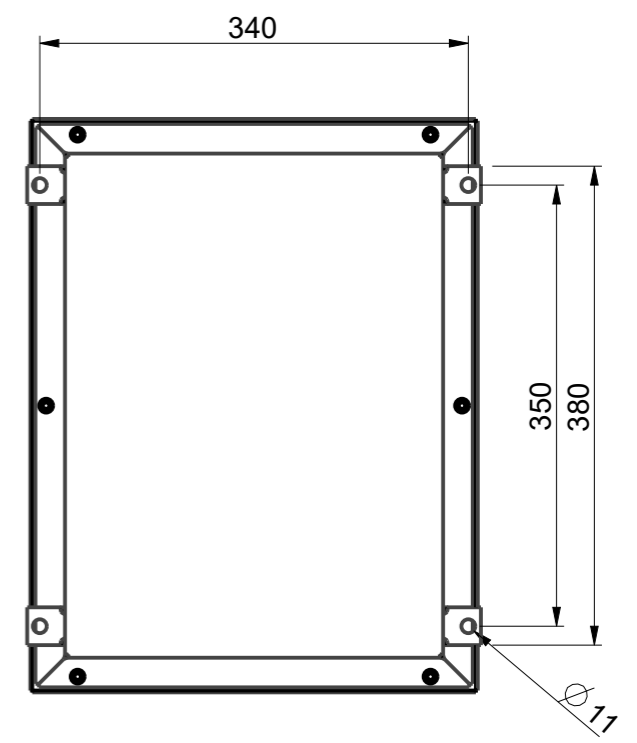
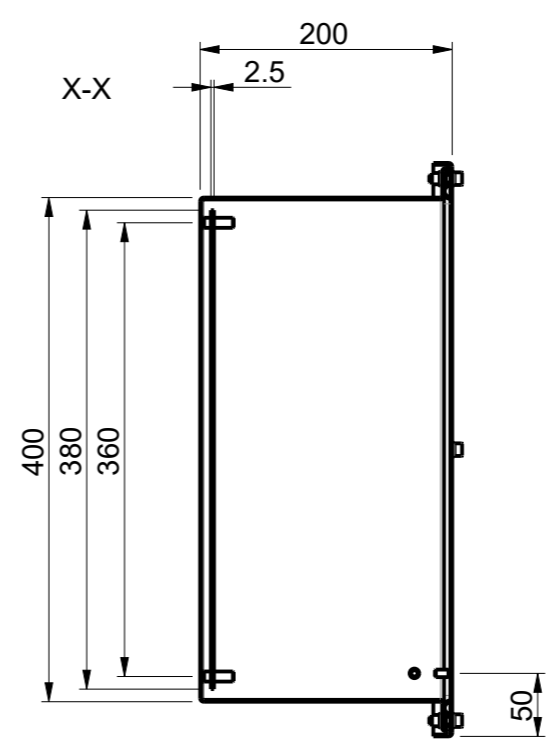
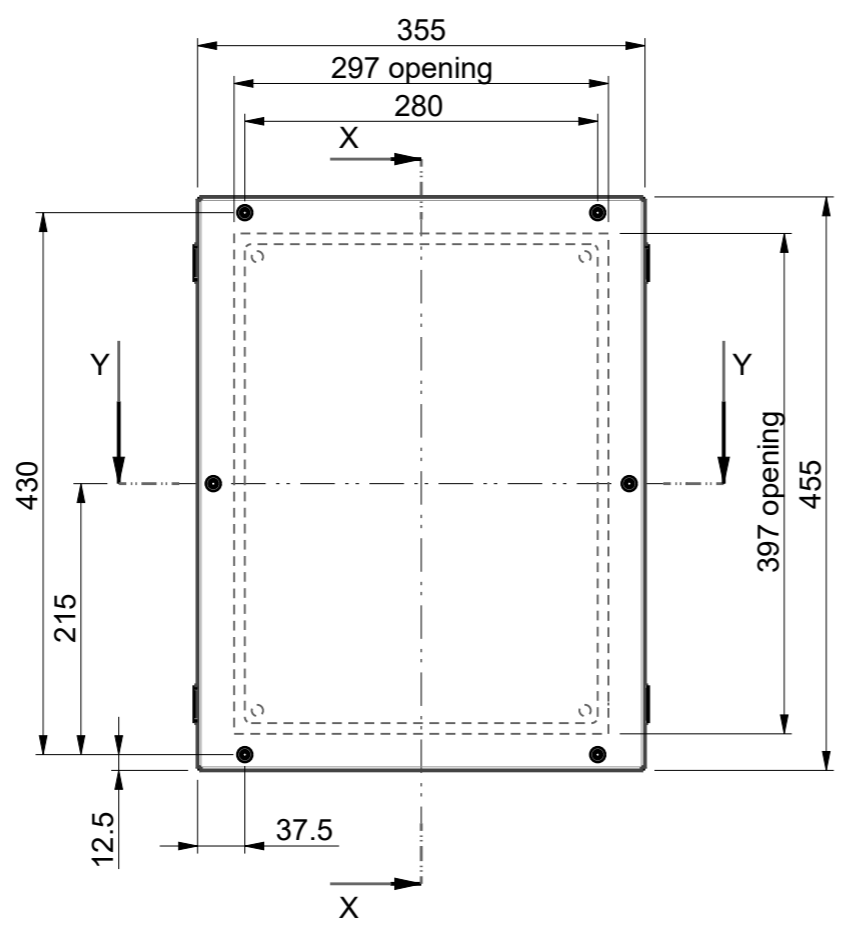
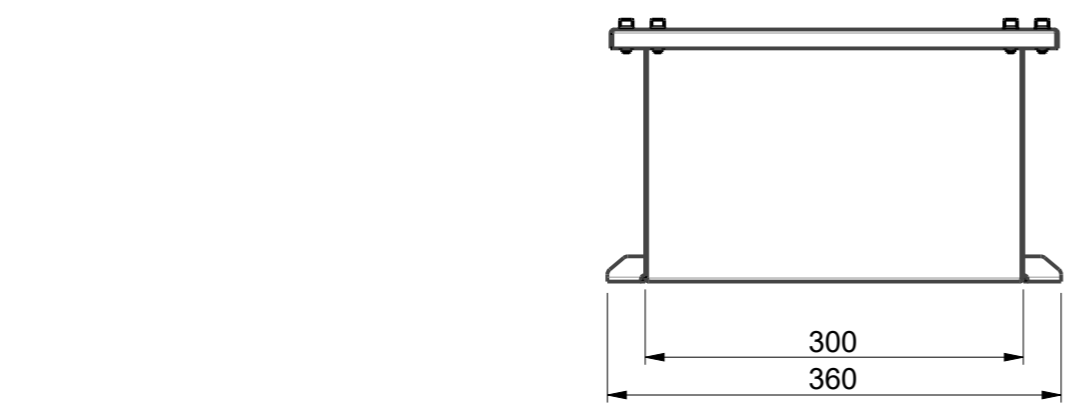

Part	Code	Description	Pcs	Weight [g/pcs]
5	PPE19209	Mounting Plate V3040	1	0
4	PPE19109	Lid VFE3040	1	0
3	PLF33	DIN912 M6x20 A4 hex socket screw	6	0
2	PUA84	DIN125 M6 A4 Washer	6	0
1	PPE19009	Base VFEP304020	1	0

Surface Treatment:	Color: RAL7035S	Weight [g]	8000
Material: Mild steel	Casemet Material:		

			Enclosure VFEP304020A	Replaces:
Casemet Oy				Replaced:
Scale	Date			Drw No:
1:6	23.7.18			A
A3	By	Ref:	Cubo V	
Sheet No: 1 (1)	Checked	Code:	VFEP304020A	
	Ctrl			