

ISO 2768-C GENERAL TOLERANCES
LINEAR AND ANGULAR DIMENSIONS

DIN 6930-C STAMPED STEEL PARTS
FLAT SURFACES / BENDINGS

ISO 13920-BG WELDINGS
WELDED CONSTRUCTIONS

Model
Drawing VSSP080808.dwg

1 2 3 4 5 6 7 8

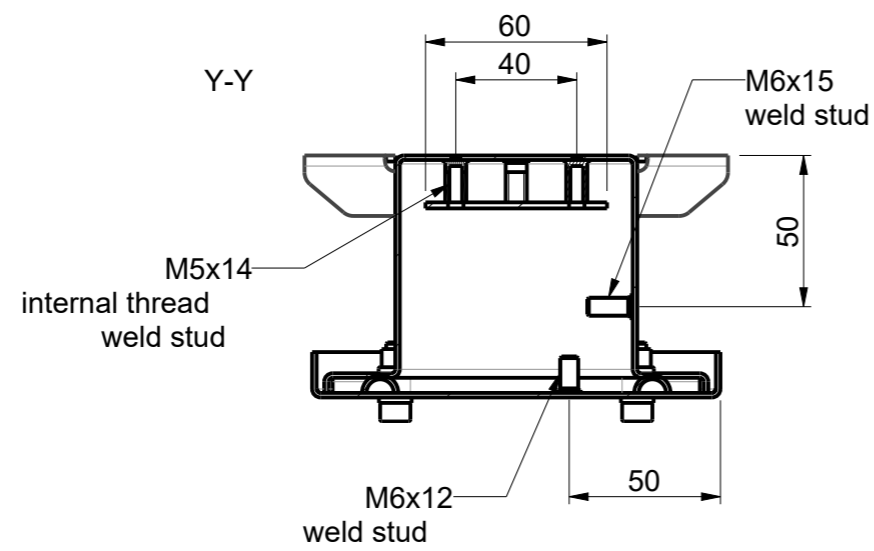
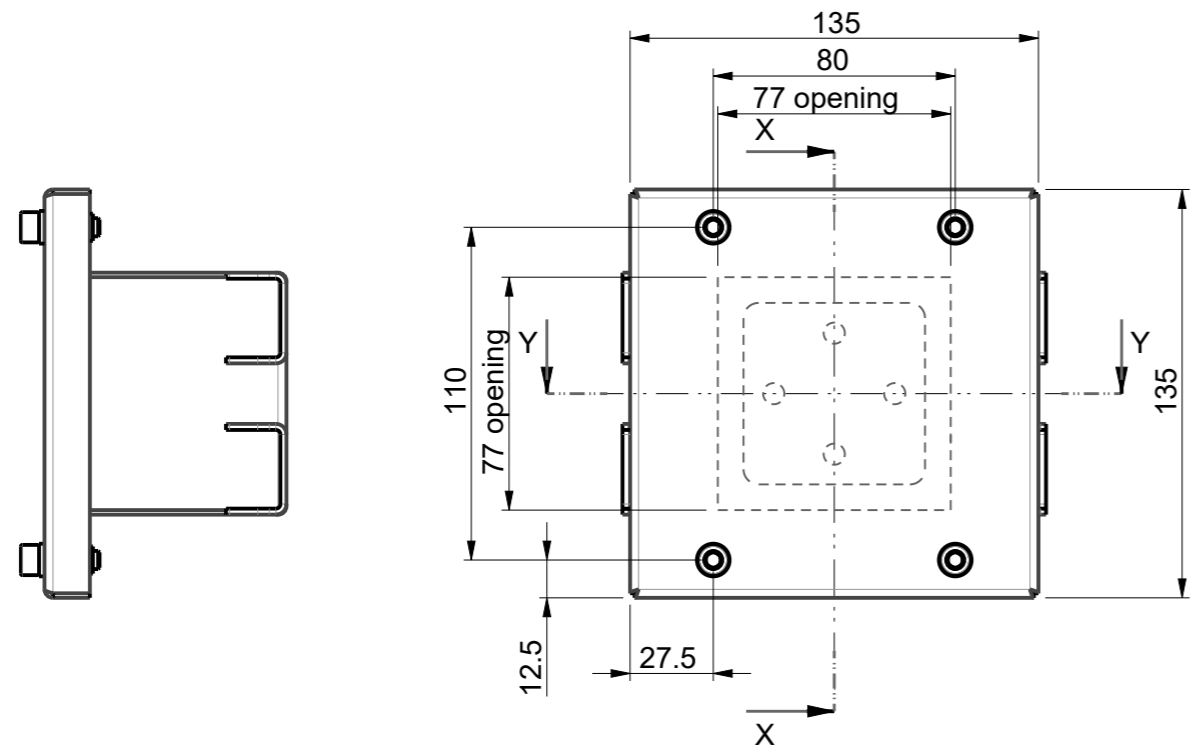
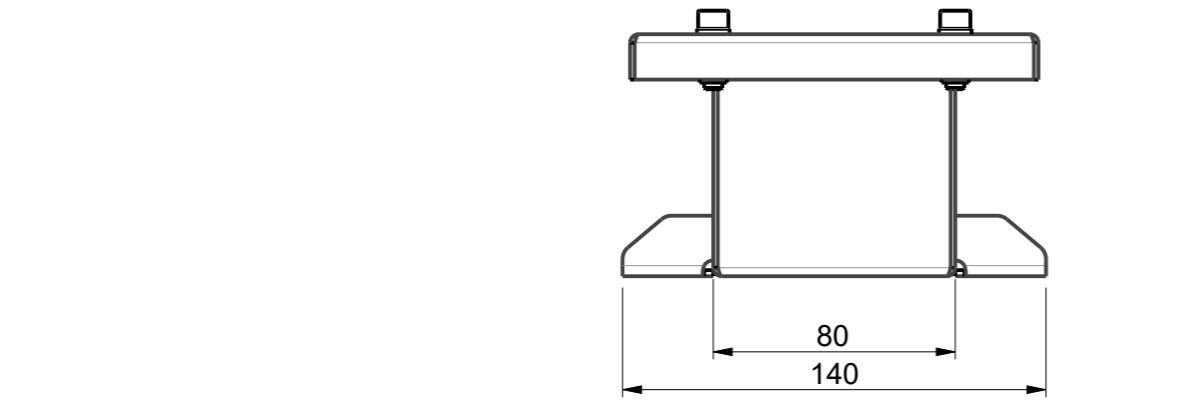

ID	Description	Date	By	Appr.
A	1.	23.7.18	PLe	

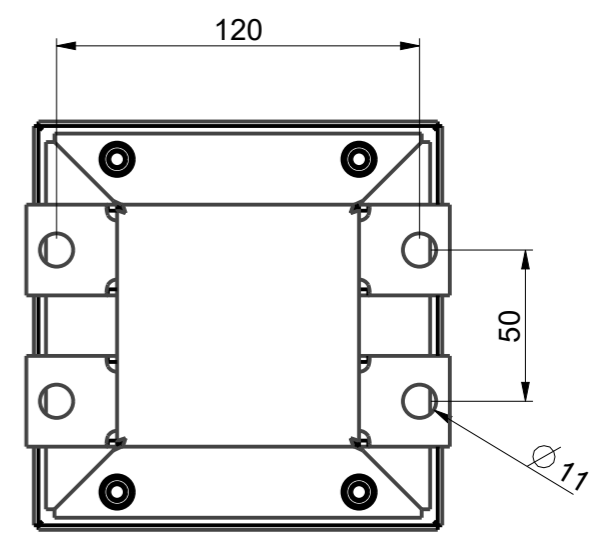
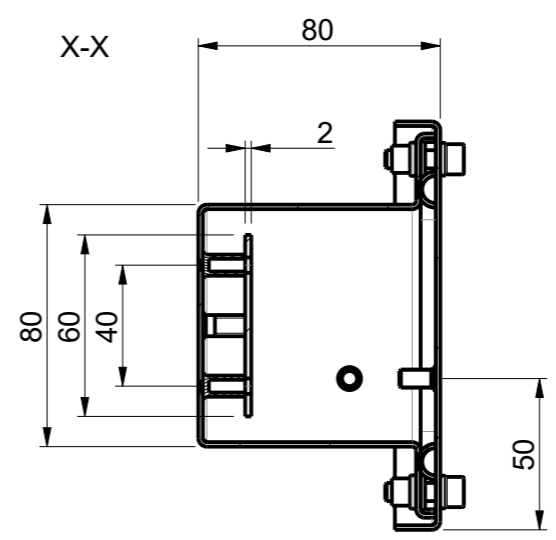

Part	Code	Description	Pcs	Weight [g/pcs]
5	PPE19200	Mounting Plate V0808	1	0
4	RST12100	Lid VSS0808	1	0
3	PLF33	DIN912 M6x20 A4 hex socket screw	4	0
2	PUA84	DIN125 M6 A4 Washer	4	0
1	RST12000	Base VSSP080808	1	0

Surface Treatment: Color: - Weight [g] 800

Material: Stainless steel Casemet Material:

			Enclosure VSSP080808	Replaces:
Casemet Oy				Replaced:
Scale	Date	23.7.18	Drw No: A	Ref:
2:5	By	PLe		Cubo V
A3	Checked			Code: VSSP080808
Sheet No: 1 (1)	Ctrl			