

ISO 2768-C GENERAL TOLERANCES  
 LINEAR AND ANGULAR DIMENSIONS  
 DIN 6930-C STAMPED STEEL PARTS  
 FLAT SURFACES / BENDINGS  
 ISO 13920-BG WELDINGS  
 WELDED CONSTRUCTIONS  
 Model Drawing VSSP151510.dwg

1 2 3 4 5 6 7 8

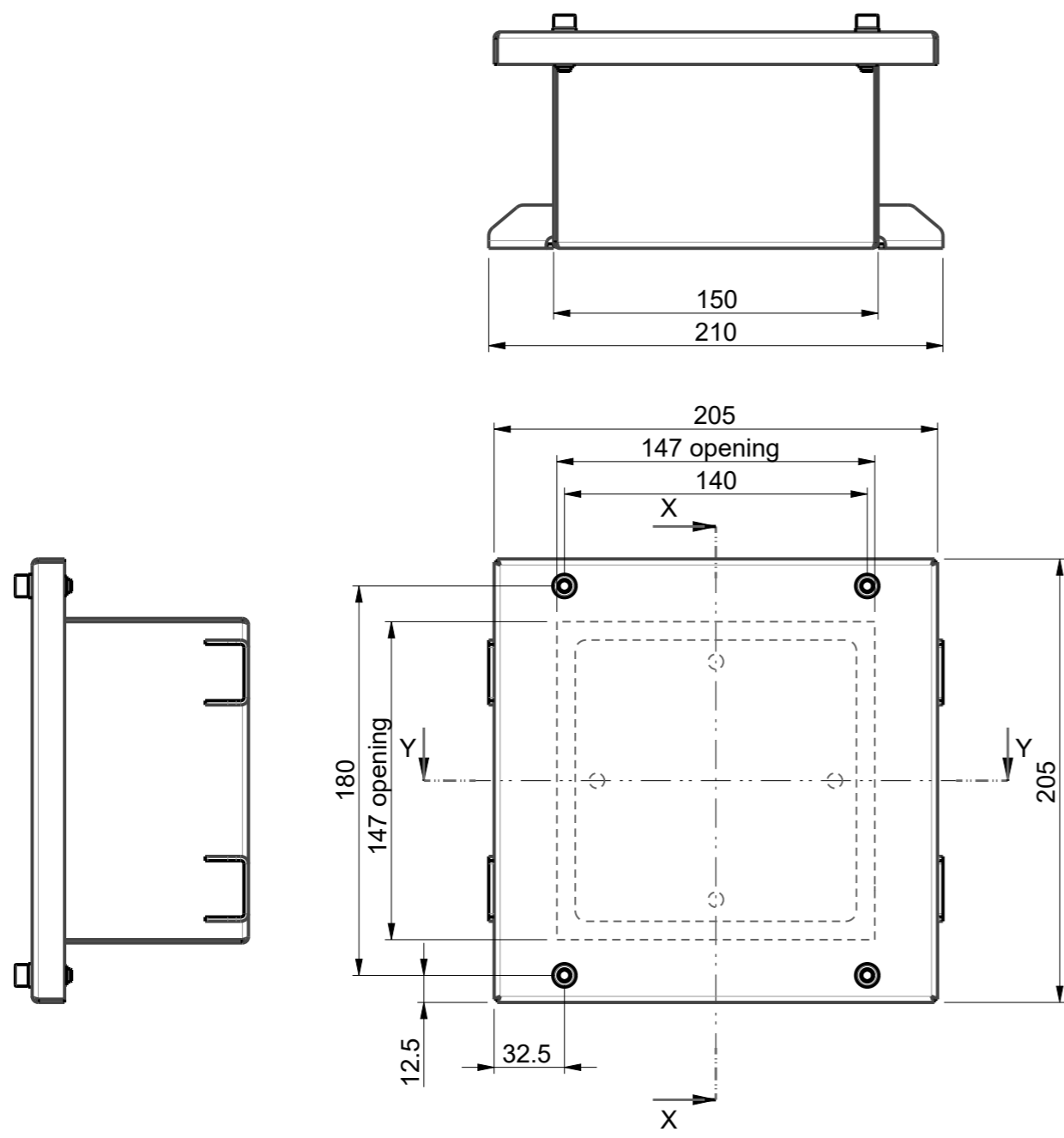

ID	Description	Date	By	Appr.
A	1.	23.7.18	PLe	

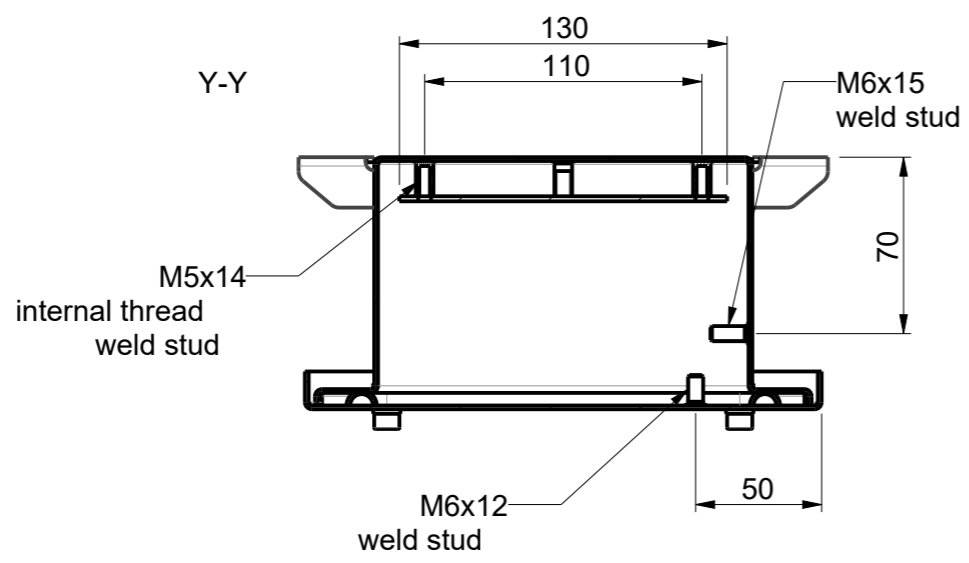
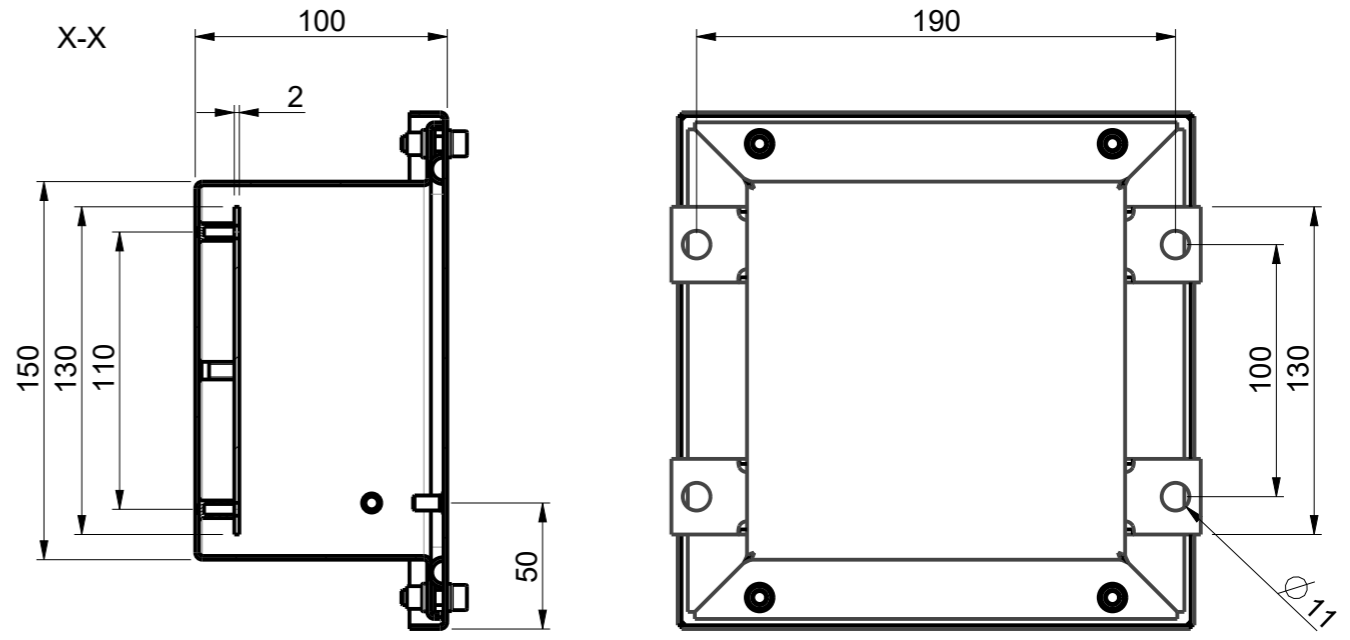

Part	Code	Description	Pcs	Weight [g/pcs]
5	PPE19202	Mounting Plate V1515	1	0
4	RST12102	Lid VSS1515	1	0
3	PLF33	DIN912 M6x20 A4 hex socket screw	4	0
2	PUA84	DIN125 M6 A4 Washer	4	0
1	RST12002	Base VSSP151510	1	0

Surface Treatment: Color: - Weight [g] 1500  
 Material: Stainless steel Casemet Material:

			Enclosure VSSP151510	Replaces:
Casemet Oy				Replaced:
Scale	Date	23.7.18	Drw No: A	Ref: Cubo V
1:3	By	PLe		Code: VSSP151510
A3	Checked			
Sheet No: 1 (1)	Ctrl			