

ISO 2768-C GENERAL TOLERANCES
LINEAR AND ANGULAR DIMENSIONS

DIN 6930-C STAMPED STEEL PARTS
FLAT SURFACES / BENDINGS

ISO 13920-BG WELDINGS
WELDED CONSTRUCTIONS

Model
Drawing VSSP302015.dwg

1 2 3 4 5 6 7 8

ID	Description	Date	By	Appr.
A	1.	23.7.18	PLe	

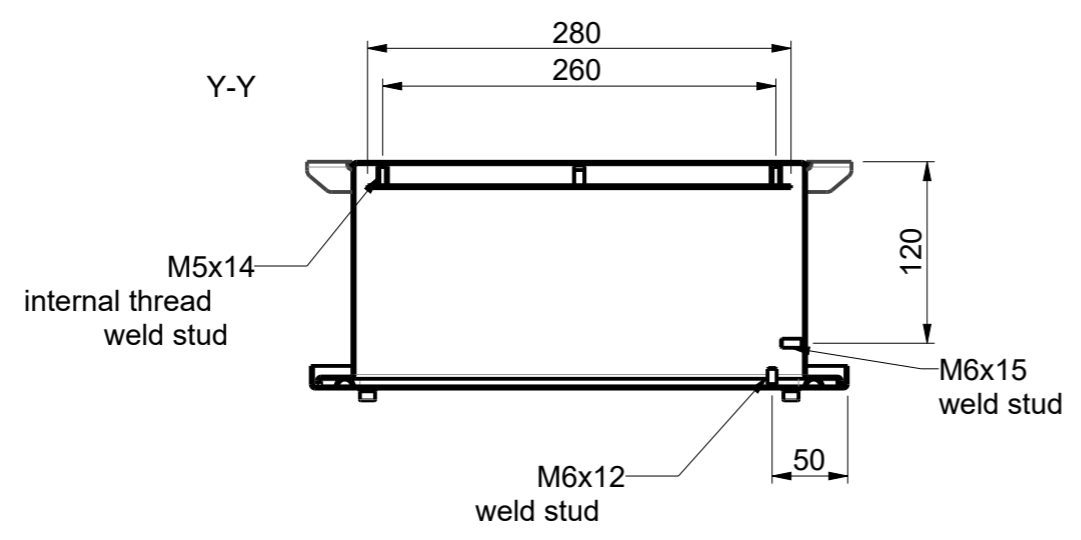
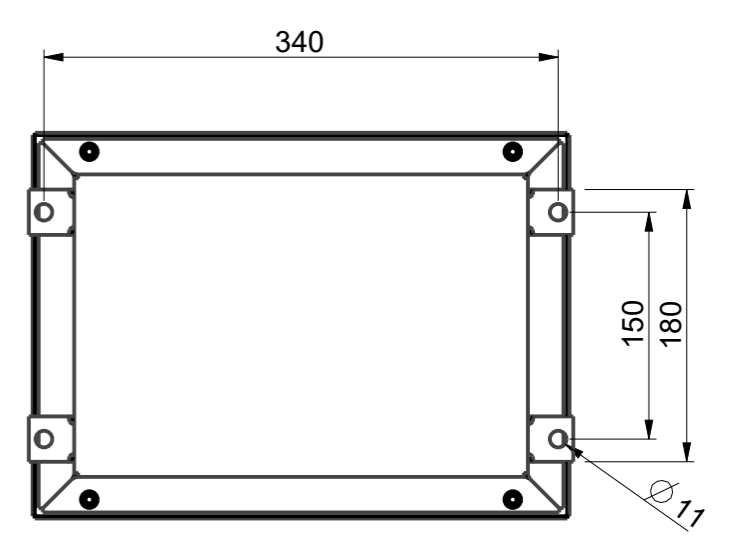
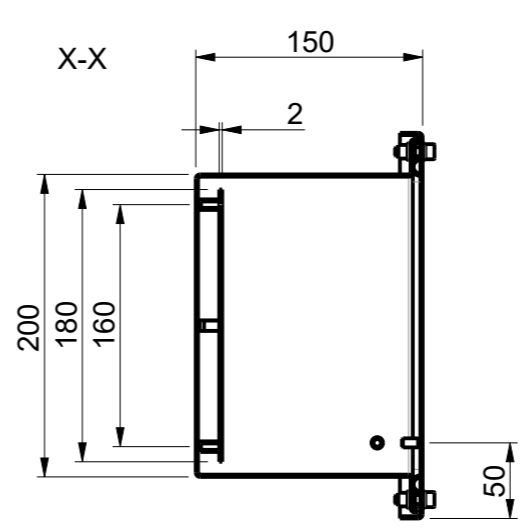
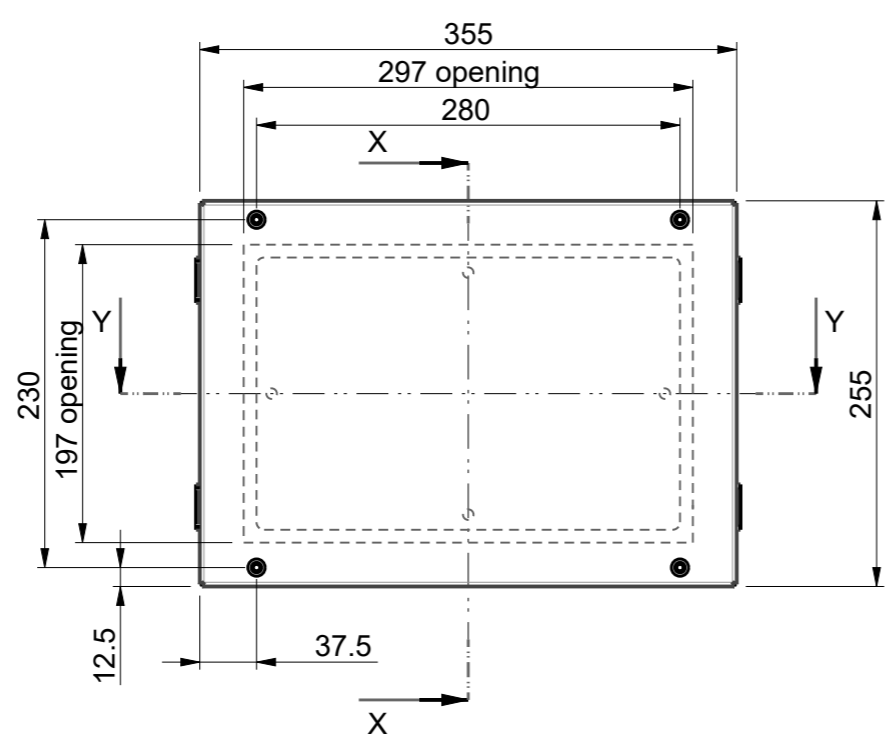
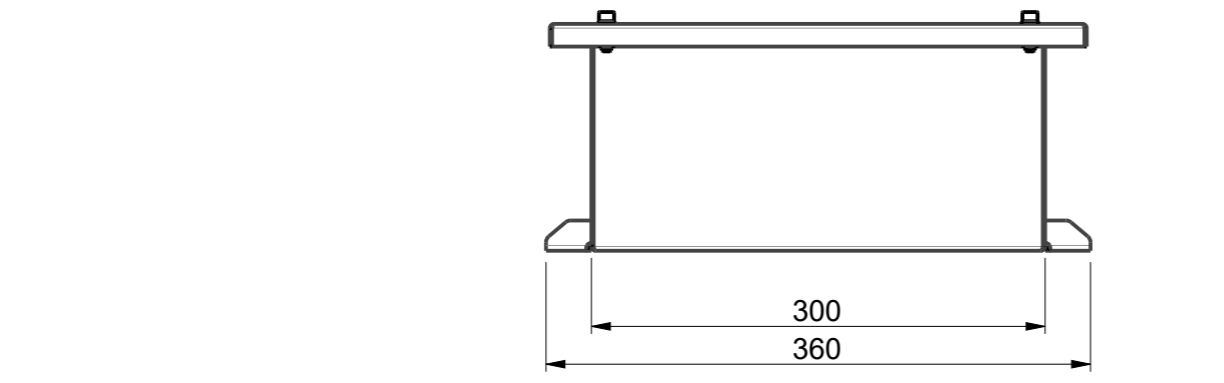

Part	Code	Description	Pcs	Weight [g/pcs]
5	PPE19204	Mounting Plate V3020	1	0
4	RST12104	Lid VSS3020	1	0
3	PLF33	DIN912 M6x20 A4 hex socket screw	4	0
2	PUA84	DIN125 M6 A4 Washer	4	0
1	RST12007	Base VSSP302015	1	0

Surface Treatment:	Color: -	Weight [g]	3500
Material: Stainless steel	Casemet Material:		

			Enclosure VSSP302015	Replaces:
Casemet Oy				Replaced:
Scale	Date	23.7.18	Drw No: A	Ref: Cubo V
1:5	By	PLe		Code: VSSP302015
A3	Checked			
Sheet No: 1 (1)	Ctrl			